

6-lead MULTILED - RGB - white binned
Enhanced optical Power LED (ThinFilm / ThinGaN)
Lead (Pb) Free Product - RoHS Compliant

LRTB G6SF



Released

Besondere Merkmale

- **Gehäusotyp:** weißes P-LCC-6 Gehäuse mit diffusem Silikon-Verguss
- **Besonderheit des Bauteils:** additive Farbmischung durch unabhängige Ansteuerung aller Chips
- **Wellenlänge:** 625 nm (rot), 528 nm (true green), 465 nm (blau)
- **Abstrahlwinkel:** Lambertscher Strahler (120°)
- **Technologie:** ThinFilm (rot), ThinGaN® (true green, blau)
- **optischer Wirkungsgrad:** 35 lm/W @ Cx=0,31; Cy=0,31
- **Gruppierungsparameter:** Lichtstärke, Farbort

- **Verarbeitungsmethode:** für alle SMT-Bestücktechniken geeignet
- **Lötmethode:** Reflow Löten
- **Vorbehandlung:** nach JEDEC Level 4
- **Gurtung:** 12 mm Gurt mit 1000/Rolle, ø180 mm
- **ESD-Festigkeit:** ESD-sensitives Bauteil nach JESD22-A114-D

Anwendungen

- Anzeigen im Innen- und Außenbereich (z.B. im Verkehrsbereich; Laufschriftanzeigen)
- Getrennte Antsteuerung der Leuchtdiodenchips zur Darstellung verschiedener Farben inklusive weiß
- Vollfarbdisplays bzw. RGB-Displays
- Blitzlicht im Handy
- Hinterleuchtung (LCD, Schalter, Tasten, Werbebeleuchtung, Allgemeinbeleuchtung)
- Einkopplung in Lichtleiter

Features

- **package:** white P-LCC-6 package with diffused silicone resin
- **feature of the device:** well defined white color groups with RGB-LED

- **wavelength:** 625 nm (red), 528 nm (true green), 465 nm (blue)
- **viewing angle:** Lambertian Emitter (120°)
- **technology:** ThinFilm (red), ThinGaN® (true green, blue)
- **optical efficiency:** 33 lm/W @ Cx=0.31; Cy=0.31

- **grouping parameter:** luminous intensity, color coordinates
- **assembly methods:** suitable for all SMT assembly methods
- **soldering methods:** reflow soldering
- **preconditioning:** acc. to JEDEC Level 4
- **taping:** 12 mm tape with 1000/reel, ø180 mm
- **ESD-withstand voltage:** ESD sensitive Device acc. JESD22-A114-D

Applications

- indoor and outdoor displays (e.g. displays for traffic; light writing displays)
- LED chips can be controlled separately to display various colors including white
- full color displays, RGB-Displays
- strobe light for cellular phones
- backlighting (LCD, switches, keys, illuminated advertising, general lighting)
- coupling into light guides

Bestellinformation
Ordering Information

Typ Type	Emissionsfarbe Color of Emission	Lichtstärke ¹⁾ Seite 23 Luminous Intensity ¹⁾ page 23 I _v (mcd)		
		white		
LRTB G6SF-V2BA-3E7F	red (13mA) true green (20mA) blue (8mA)	900...2240		
		red	true green	blue
	lv (typ) @20mA each color	600	980	250

Bestellinformation
Ordering Information

Typ Type	Bestellnummer Ordering Code
LRTB G6SF-V2BA-3E7F	Q65110A7501

Anm.: Die oben genannten Typbezeichnungen umfassen die bestellbaren Selektionen. Diese bestehen aus wenigen Helligkeitsgruppen (siehe **Seite 7** für nähere Informationen). Es wird nur eine einzige Helligkeitsgruppe pro Gurt geliefert. Z.B.: LRTB G6SF-V2BA-3E7F bedeutet, dass auf dem Gurt nur eine der Helligkeitsgruppen V2, AA, AB oder BA enthalten ist.
Um die Liefersicherheit zu gewährleisten, können einzelne Helligkeitsgruppen nicht bestellt werden.

Gleiches gilt für die Farben, bei denen Farbortgruppen gemessen und gruppiert werden. Pro Gurt wird nur eine Farbortgruppe geliefert. Z.B.: LRTB G6SF-V2BA-3E7F bedeutet, dass auf dem Gurt nur eine der Farbortgruppen -3E, -3F, -4D, -4E, -4F, -5D, -5E, -5F, -6D, -6E, -6F, -7D, -7E oder -7F enthalten ist (siehe **Seite 5** für nähere Information).
Um die Liefersicherheit zu gewährleisten, können einzelne Farbortgruppen nicht bestellt werden.

Note: The above Type Numbers represent the order groups which include only a few brightness groups (see **page 7** for explanation). Only one group will be shipped on each reel (there will be no mixing of two groups on each reel). E.g. LRTB G6SF-V2BA-3E7F means that only one group V2, AA, AB or BA will be shippable for any one reel.

In order to ensure availability, single brightness groups will not be orderable.

In a similar manner for colors where chromaticity coordinate groups are measured and binned, single chromaticity coordinate groups will be shipped on any one reel. E.g. LRTB G6SF-V2BA-3E7F means that only 1 chromaticity coordinate group -3E, -3F, -4D, -4E, -4F, -5D, -5E, -5F, -6D, -6E, -6F, -7D, -7E or -7F will be shippable on each reel (see **page 5** for explanation).

In order to ensure availability, single chromaticity coordinate groups will not be orderable..

Grenzwerte
Maximum Ratings

Bezeichnung Parameter	Symbol Symbol	Werte Values			Einheit Unit
		red	true green	blue	
Betriebstemperatur Operating temperature range	T_{op}	- 40 ... + 100			°C
Lagertemperatur Storage temperature range	T_{stg}	- 40 ... + 100			°C
Sperrschichttemperatur Junction temperature	T_j	+ 125			°C
Durchlassstrom Forward current ($T_S=25^\circ\text{C}$)	I_F	50			mA
Durchlassstrom Forward current ($T_S=25^\circ\text{C}$) (min)	I_F	-	5	mA	
Stoßstrom Surge current $t_p = 10 \mu\text{s}$, $D = 0.005$, $T_S=25^\circ\text{C}$	I_{FM}	100	300	mA	
Sperrspannung ^{2) Seite 23} Reverse voltage ^{2) page 23} ($T_S=25^\circ\text{C}$)	V_R	12	5	V	

Kennwerte
Characteristics
 $(T_S = 25\text{ °C})$

Bezeichnung Parameter	Symbol Symbol	Werte Values			Einheit Unit
		red	true green	blue	
Wellenlänge des emittierten Lichtes (typ.) Wavelength at peak emission $I_F = 20\text{ mA}$	λ_{peak}	634	529	460	nm
Dominantwellenlänge ^{4) Seite 23} Dominant wavelength ^{4) page 23} (typ.) $I_F = 20\text{ mA}$	λ_{dom}	625	534	465	nm nm nm
Spektrale Bandbreite bei 50 % $I_{\text{rel max}}$ Spectral bandwidth at 50 % $I_{\text{rel max}}$ $I_F = 20\text{ mA}$	$\Delta\lambda$	20	33	25	nm
Abstrahlwinkel bei 50 % I_V (Vollwinkel) Viewing angle at 50 % I_V	2φ	120			Grad deg.
Durchlassspannung ^{5) Seite 23} Forward voltage ^{5) page 23} $I_F = 20\text{ mA}$	(min.) V_F (typ.) V_F (max.) V_F	1.9 2.05 2.5	2.9 3.2 3.7		V V V
Sperrstrom (typ.) Reverse current (max.) $V_R = 5\text{ V}$ (blue / true green); 12 V (red)	I_R I_R	0.02 10	0.01 10		μA μA
Optischer Wirkungsgrad am Farbort 0,31/0,31 (typ.) Optical efficiency on color coordinate 0.31/0.31	η_{opt}	160	70	44	lm/W
Wärmewiderstand Thermal resistance					
Sperrschicht/Umgebung ^{3) Seite 23} 1 chip on (max.) Junction/ambient ^{3) page 23} 3 chips on (max.)	$R_{\text{th JA}}$ $R_{\text{th JA}}$	440** 700**	340** 600**		K/W K/W
Sperrschicht/Löt看 (max.) Junction/solder point	$R_{\text{th JS}}$	280**	180**		K/W

* Einzelgruppen siehe Seite 7
Individual groups on page 7

** $R_{\text{th}}(\text{max})$ basiert auf statistischen Werten
 $R_{\text{th}}(\text{max})$ is based on statistic values

Farbortgruppen^{6) 7)} Seite 23

Chromaticity Coordinate Groups^{6) 7)} page 23

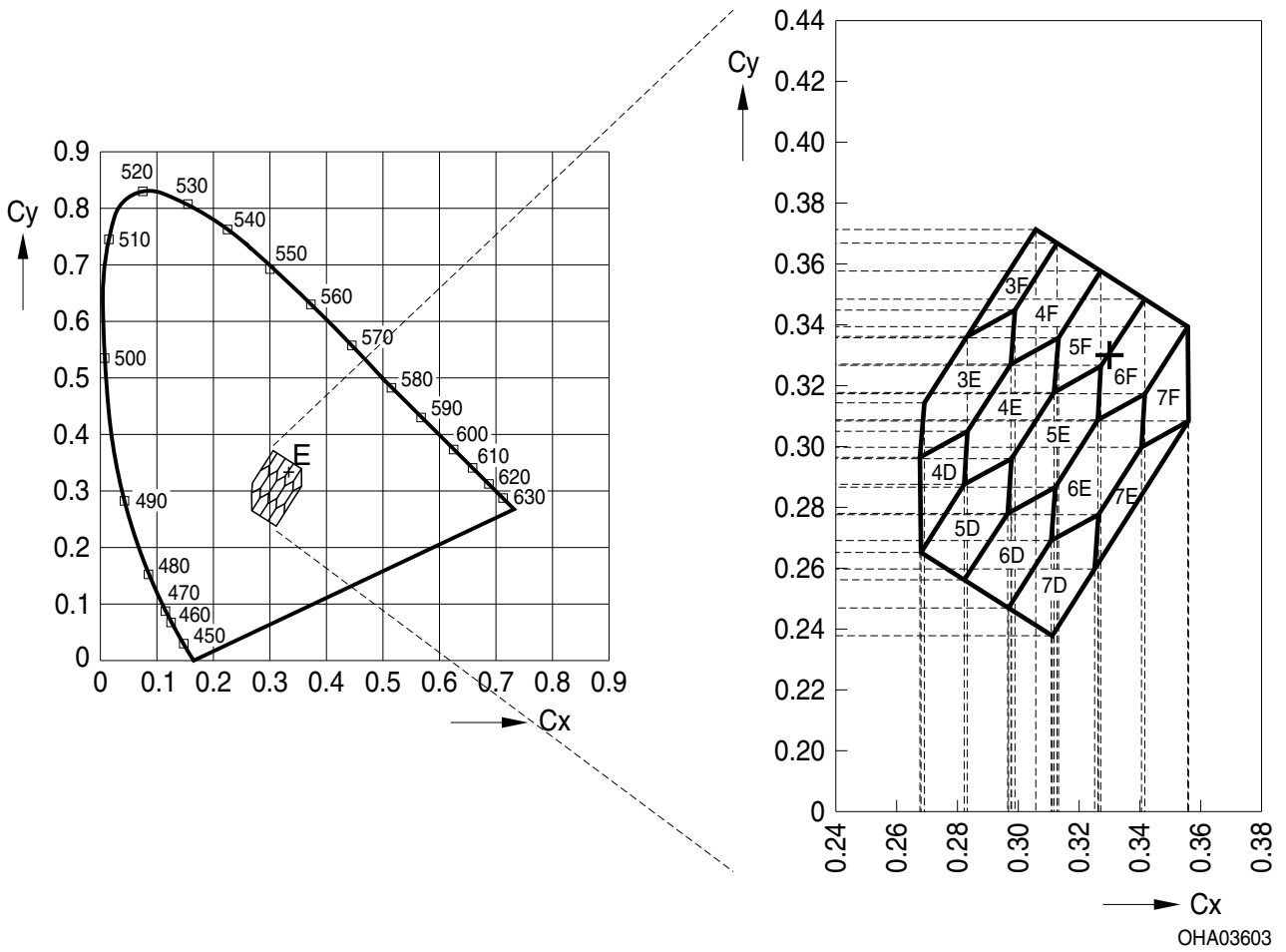

Gruppe Group	Cx	Cy	Gruppe Group	Cx	Cy	Gruppe Group	Cx	Cy
			3E	0.268	0.296	3F	0.283	0.336
				0.269	0.314		0.306	0.371
				0.283	0.336		0.313	0.367
				0.299	0.345		0.299	0.345
				0.298	0.327		0.283	0.336
				0.283	0.305			
				0.268	0.296			
4D	0.268	0.296	4E	0.282	0.287	4F	0.298	0.327
	0.283	0.305		0.283	0.305		0.299	0.345
	0.282	0.287		0.298	0.327		0.313	0.367
	0.268	0.265		0.313	0.335		0.327	0.357
	0.268	0.296		0.312	0.318		0.313	0.335
				0.298	0.296		0.298	0.327
				0.282	0.287			
5D	0.268	0.265	5E	0.296	0.278	5F	0.312	0.318
	0.282	0.287		0.298	0.296		0.313	0.335
	0.298	0.296		0.312	0.318		0.327	0.357
	0.296	0.278		0.328	0.326		0.342	0.348
	0.282	0.256		0.326	0.308		0.328	0.326
	0.268	0.265		0.312	0.286		0.312	0.318
6D	0.282	0.256	6E	0.311	0.269	6F	0.326	0.308
	0.296	0.278		0.312	0.286		0.328	0.326
	0.312	0.286		0.326	0.308		0.342	0.348
	0.311	0.269		0.342	0.317		0.356	0.339
	0.297	0.247		0.341	0.299		0.342	0.317
	0.282	0.256		0.326	0.277		0.326	0.308
				0.311	0.269			
7D	0.297	0.247	7E	0.325	0.259	7F	0.341	0.299
	0.311	0.269		0.326	0.277		0.342	0.317
	0.326	0.277		0.341	0.299		0.356	0.339
	0.325	0.259		0.356	0.308		0.356	0.308
	0.311	0.237		0.325	0.259		0.341	0.299
	0.297	0.247						

Anm.: Die Farbkoordinaten des Mischlichtes können innerhalb des gekennzeichneten Bereichs des Farbdreiecks erwartet werden.

Note: The color coordinates of the mixed light can be expected within the marked area of the color triangle

Helligkeits-Gruppierungsschema Brightness Groups

Helligkeitsgruppe Brightness Group	Lichtstärke ²⁾ Seite 19 Luminous Intensity ²⁾ page 19 I_v (mcd)
V2	1000 (typ.)
AA	1250 (typ.)
AB	1600 (typ.)
BA	2000 (typ.)

Anm.: Die Standardlieferform von Serientypen beinhaltet eine Familiengruppe. Diese besteht aus 4 Helligkeitsgruppen. Einzelne Helligkeitsgruppen sind nicht bestellbar.

Note: The standard shipping format for serial types includes a family group of 4 individual brightness groups. Individual brightness groups cannot be ordered.

Gruppenbezeichnung auf Etikett

Group Name on Label

Beispiel: V2-3E

Example: V2-3E

Helligkeitsgruppe Brightness Group	Farbortgruppe Color coordinates
V2	3E

Anm.: In einer Verpackungseinheit / Gurt ist immer nur eine Helligkeitsgruppe pro Farbe enthalten.

Note: No packing unit / tape ever contains more than one brightness group per color.

Relative spektrale Emission^{6) Seite 23}

Relative Spectral Emission^{6) page 23}

$V(\lambda)$ = spektrale Augenempfindlichkeit / Standard eye response curve

$I_{rel} = f(\lambda); T_S = 25\text{ °C}; I_F = 20\text{ mA}$

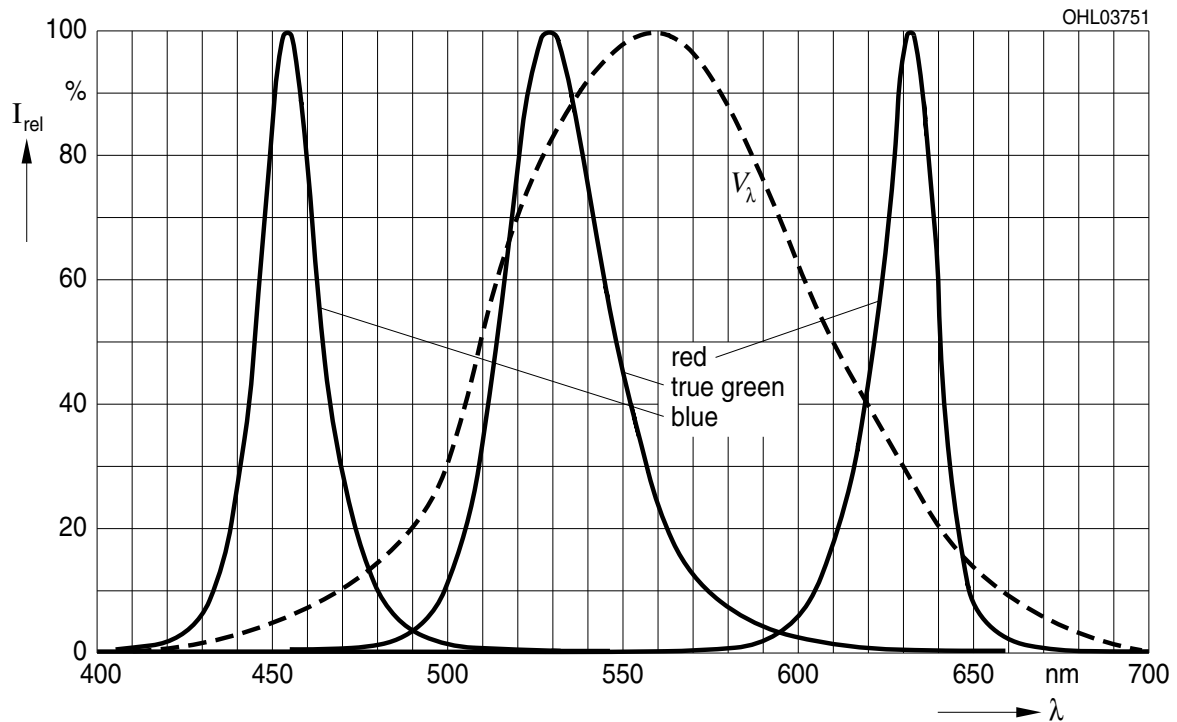

Abstrahlcharakteristik^{6) Seite 23}

Radiation Characteristic^{6) page 23}

$I_{rel} = f(\varphi); T_S = 25\text{ °C}$

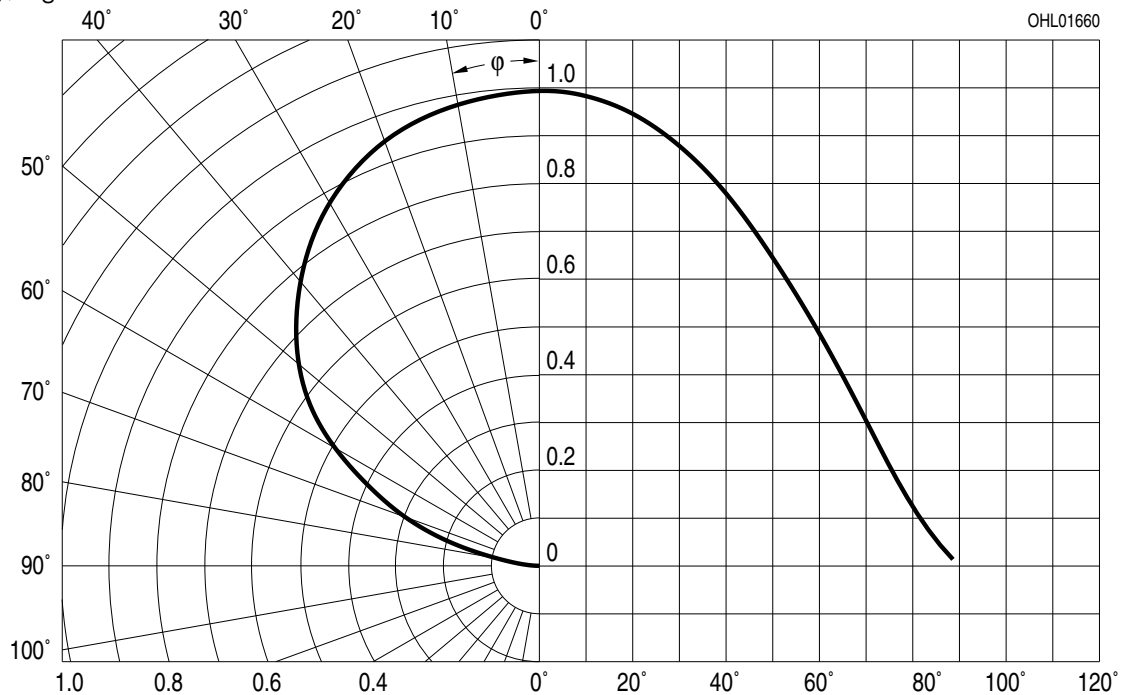

Durchlassstrom⁶⁾ Seite 23

Forward Current⁶⁾ page 23

$I_F = f(V_F); T_S = 25\text{ °C};$ red

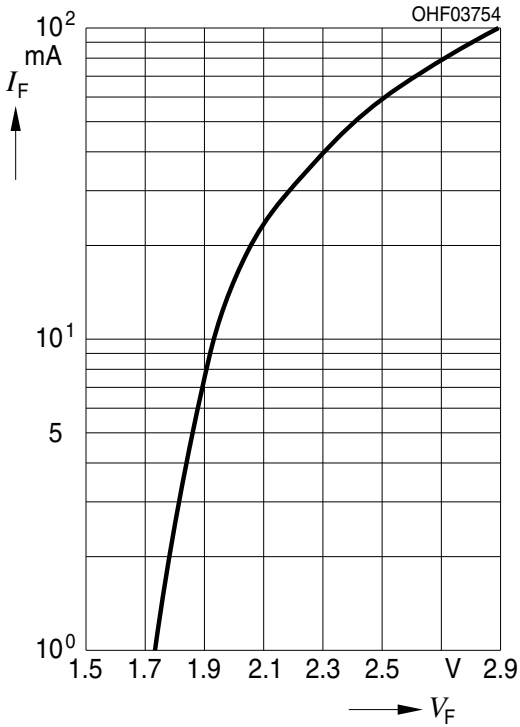

Durchlassstrom⁶⁾ Seite 23

Forward Current⁶⁾ page 23

$I_F = f(V_F); T_S = 25\text{ °C};$ blue, true green

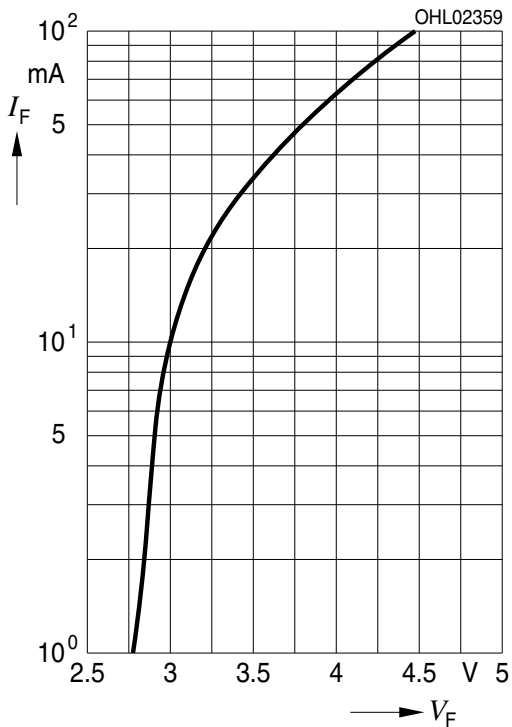

Relative Lichtstärke^{6) 7)} Seite 23

Relative Luminous Intensity^{6) 7)} page 23

$I_V/I_V(20\text{ mA}) = f(I_F); T_S = 25\text{ °C}$

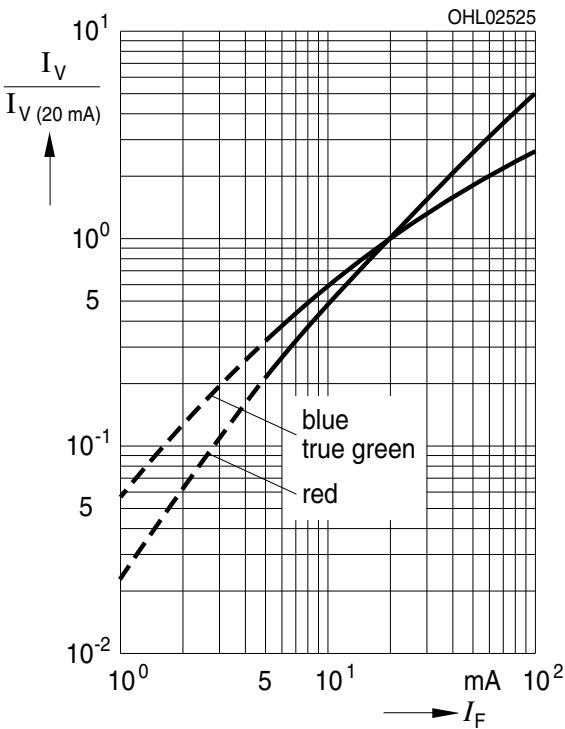

Dominante Wellenlänge⁶⁾ Seite 23

Dominant Wavelength⁶⁾ page 23

blue, $\lambda_{\text{dom}} = f(I_F); T_S = 25\text{ °C}$

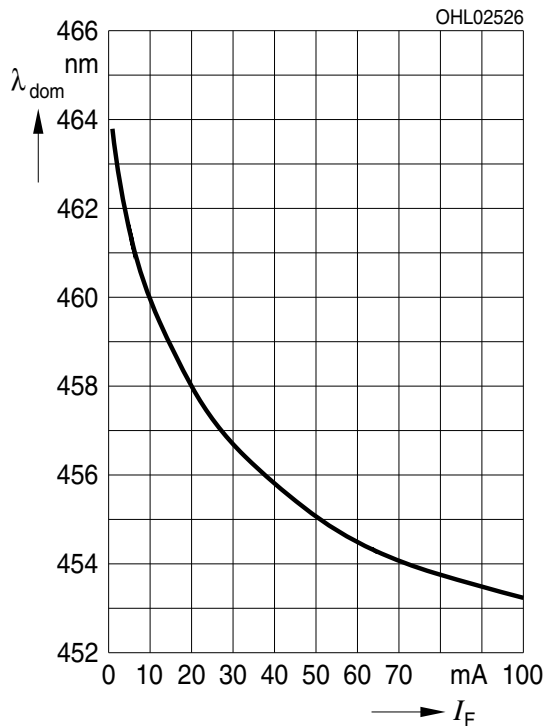

Dominante Wellenlänge⁶⁾ Seite 23

Dominant Wavelength⁶⁾ page 23

true green, $\lambda_{\text{dom}} = f(I_F); T_S = 25\text{ °C}$

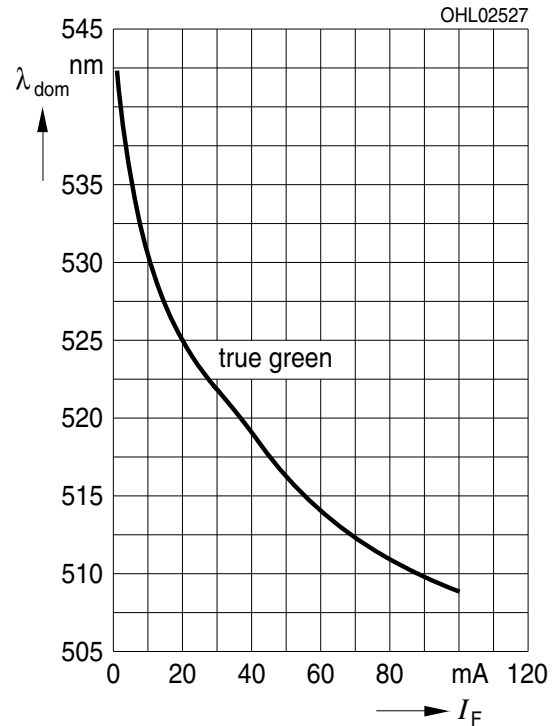

Relative Lichtstärke⁶⁾ Seite 23

Relative Luminous Intensity⁶⁾ page 23

$I_V/I_V(25\text{ °C}) = f(T_S); I_F = 20\text{ mA}$

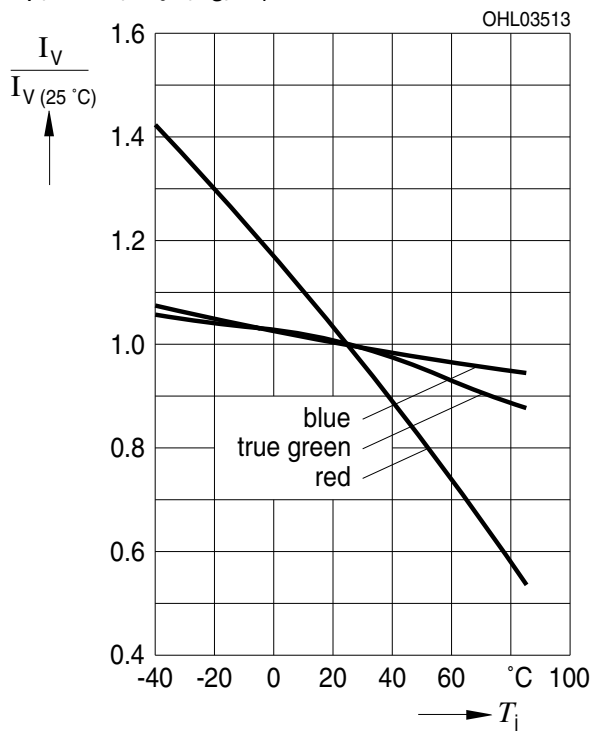

Relative Lichtstärke^{6) 7) Seite 23}

Relative Luminous Intensity^{6) 7) page 23}

$$I_V/I_{Vgroup} = f(I_F/I_{Fgroup}); T_S = 25\text{ °C}$$

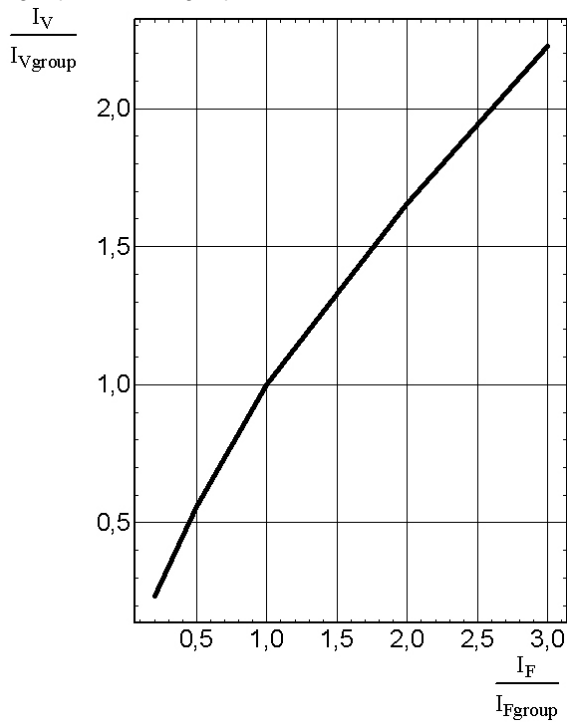

Farbortverschiebung^{2) Seite 23}

Chromaticity Coordinate Shift^{2) page 23}

$$\Delta Cx, \Delta Cy = f(I_F/I_{Fgroup}); T_S = 25\text{ °C}$$

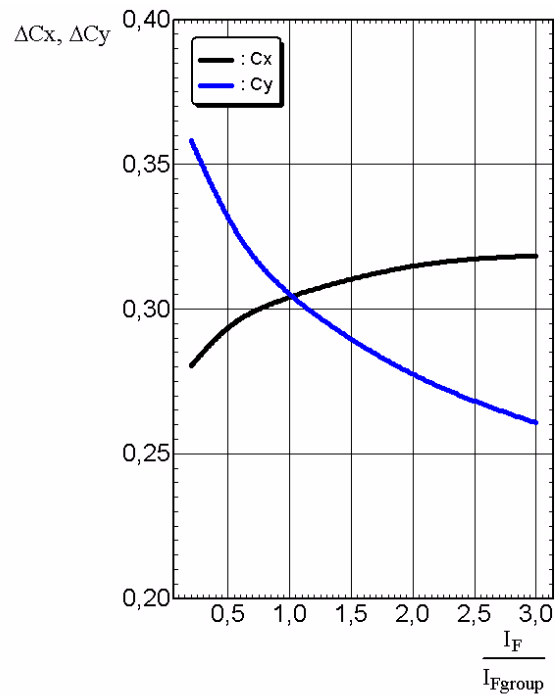

Relative Lichtstärke^{6) 7) Seite 23}

Relative Luminous Intensity^{6) 7) page 23}

$$I_V/I_V(25\text{ °C}) = f(T_j); I_F = I_{Fgroup}$$

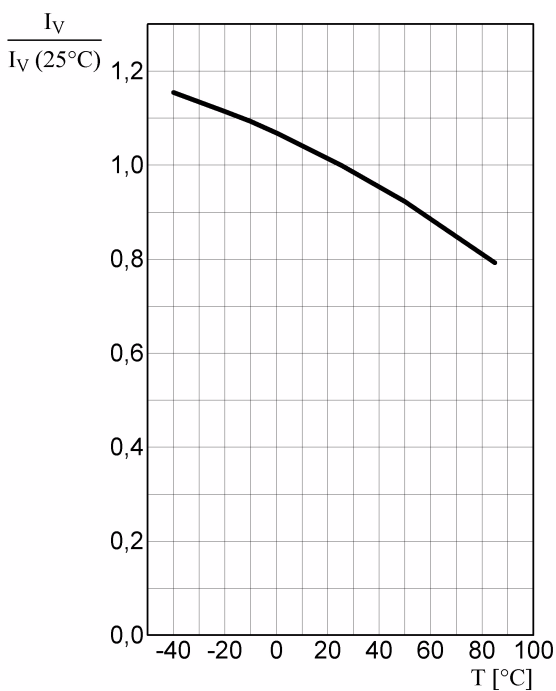

Farbortverschiebung^{2) Seite 23}

Chromaticity Coordinate Shift^{2) page 23}

$$\Delta Cx, \Delta Cy = f(T_j); I_F = I_{Fgroup}$$

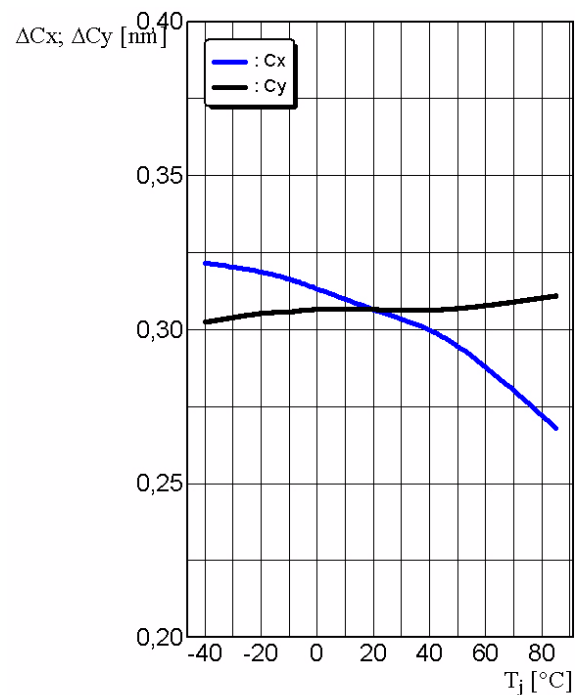

Maximal zulässiger Durchlassstrom rot
Max. Permissible Forward Current red
 $I_F = f(T)$; 1 chip on

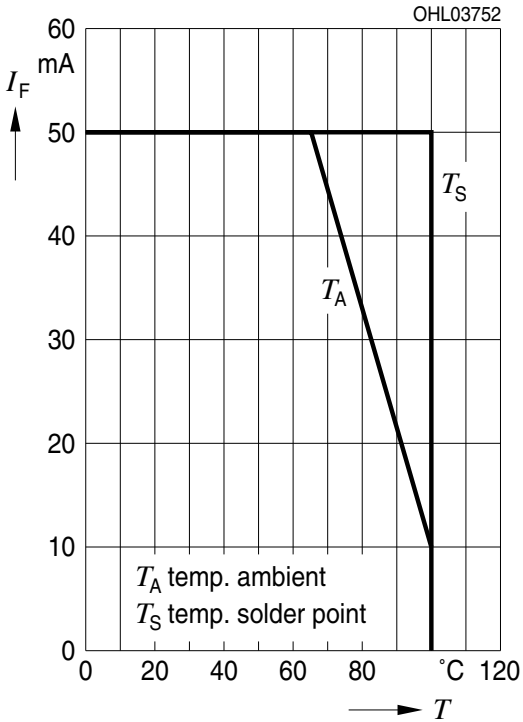

Maximal zulässiger Durchlassstrom red
Max. Permissible Forward Current red
 $I_F = f(T)$; 3 chips on

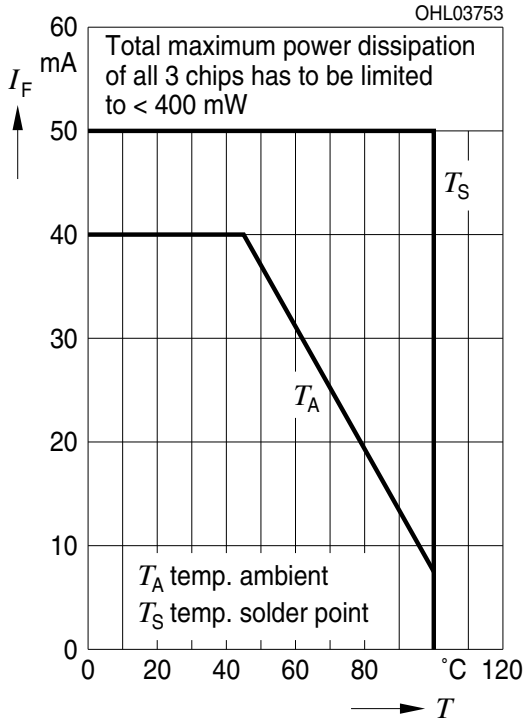

Maximal zulässiger Durchlassstrom true grün
Max. Permissible Forward Current true green
 $I_F = f(T)$; 1 chip on

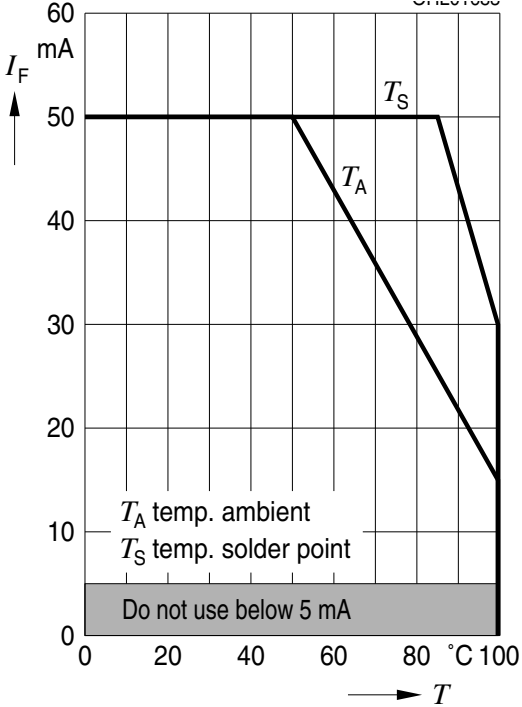

Maximal zulässiger Durchlassstrom true grün
Max. Permissible Forward Current true green
 $I_F = f(T)$; 3 chips on

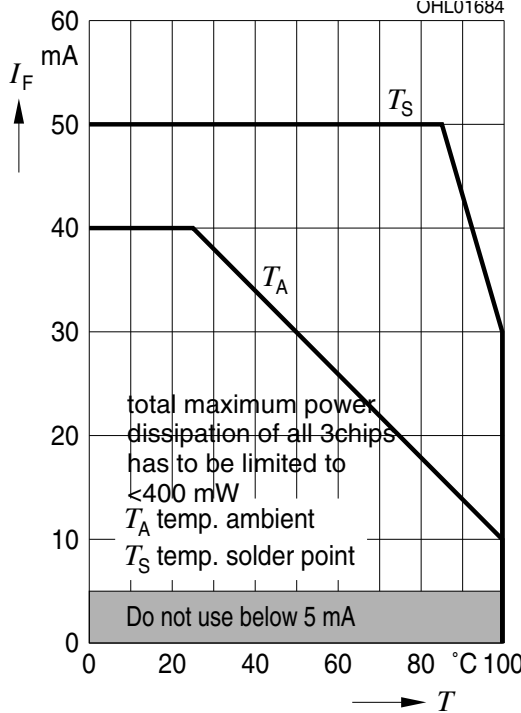

Maximal zulässiger Durchlassstrom blau
Max. Permissible Forward Current blue

$I_F = f(T)$; 1 chip on

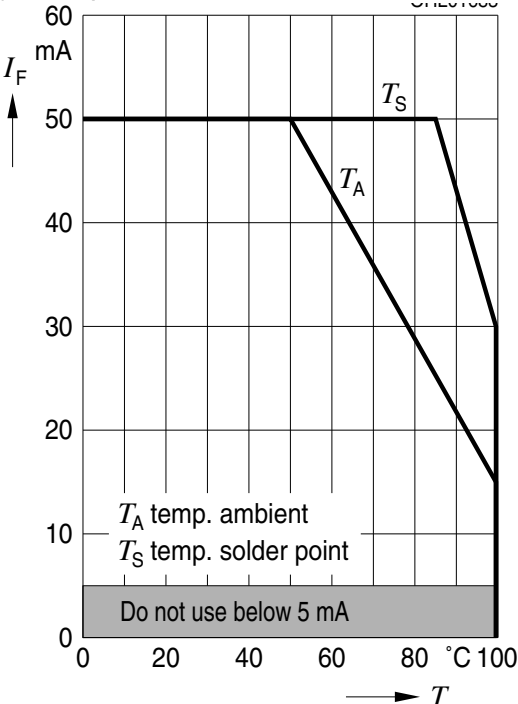

Maximal zulässiger Durchlassstrom blau
Max. Permissible Forward Current blue

$I_F = f(T)$; 3 chips on

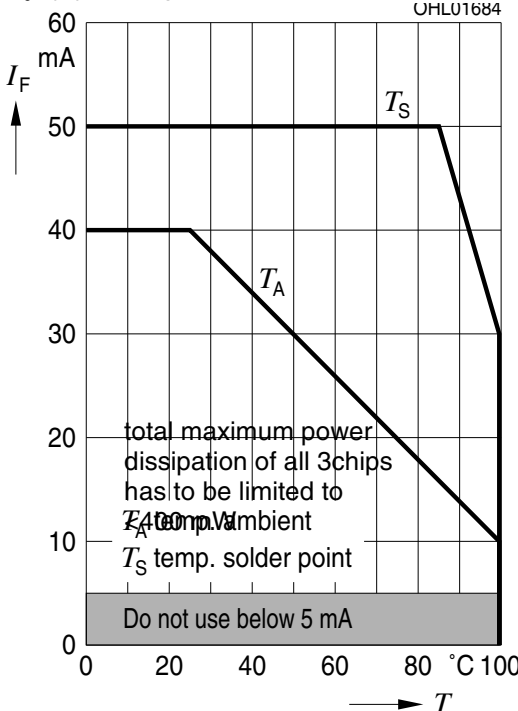

Zulässige Impulsbelastbarkeit
Permissible Pulse Handling Capability
 Duty cycle $D =$ parameter, $T_A = 25\text{ °C}$
 $I_F = f(t_p)$; red; 1 chip on

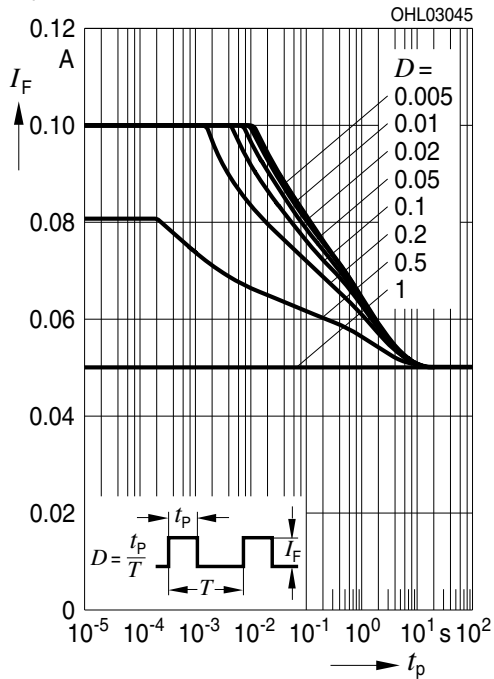

Zulässige Impulsbelastbarkeit
Permissible Pulse Handling Capability
 Duty cycle $D =$ parameter, $T_A = 85\text{ °C}$
 $I_F = f(t_p)$; red; 1 chip on

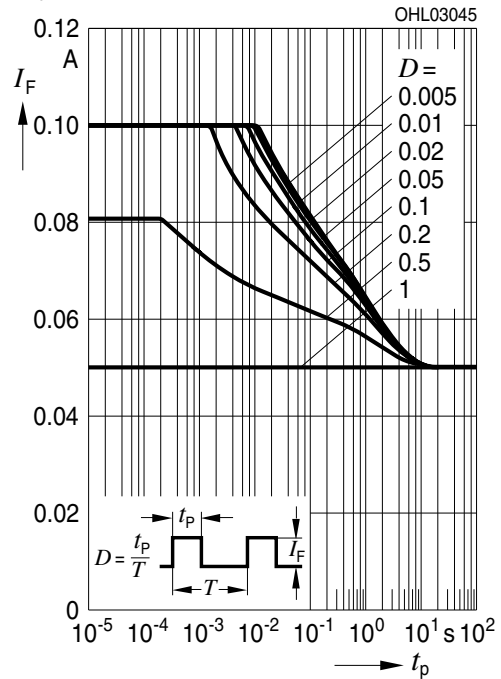

Zulässige Impulsbelastbarkeit
Permissible Pulse Handling Capability
 Duty cycle $D =$ parameter, $T_A = 25\text{ °C}$
 $I_F = f(t_p)$; red; 3 Chips on

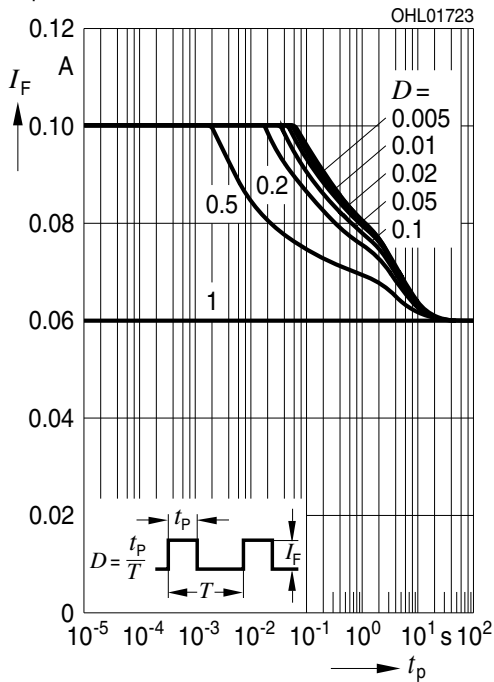

Zulässige Impulsbelastbarkeit
Permissible Pulse Handling Capability
 Duty cycle $D =$ parameter, $T_A = 85\text{ °C}$
 $I_F = f(t_p)$; red; 3 Chips on

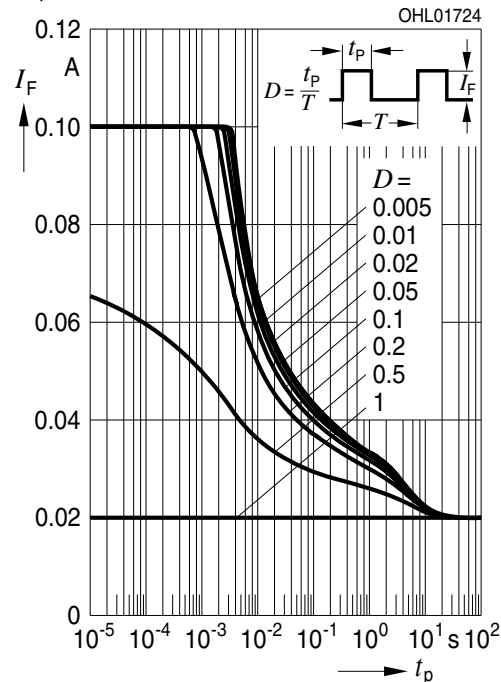

Zulässige Impulsbelastbarkeit
Permissible Pulse Handling Capability

Duty cycle $D =$ parameter, $T_A = 25\text{ °C}$

$I_F = f(t_p)$; true green; 1 chip on

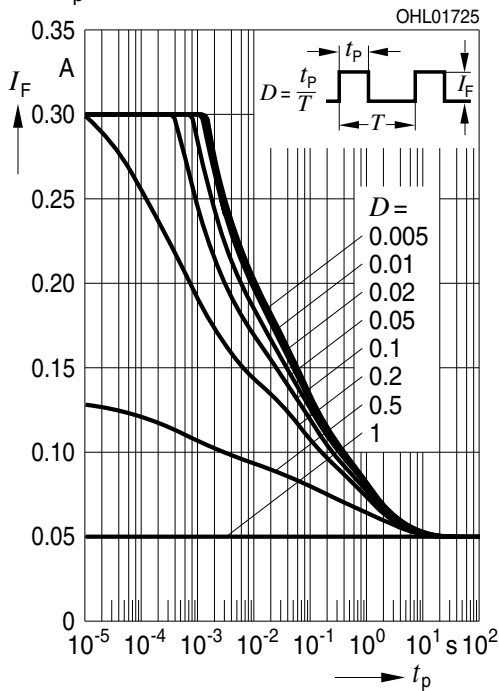

Zulässige Impulsbelastbarkeit
Permissible Pulse Handling Capability

Duty cycle $D =$ parameter, $T_A = 85\text{ °C}$

$I_F = f(t_p)$; true green; 1 chip on

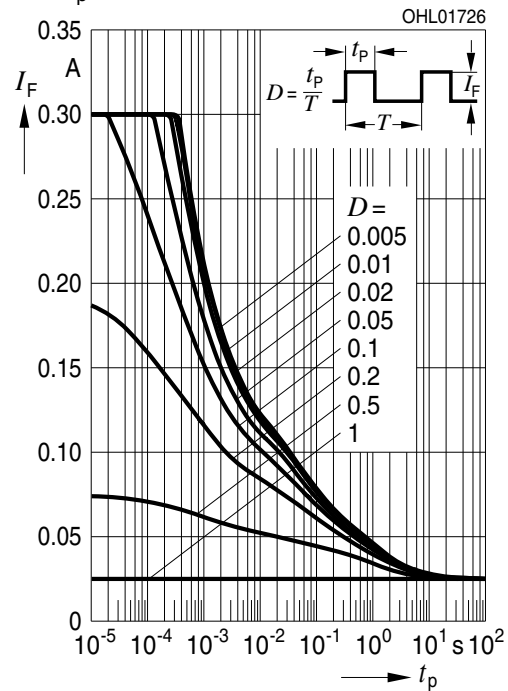

Zulässige Impulsbelastbarkeit
Permissible Pulse Handling Capability

Duty cycle $D =$ parameter, $T_A = 25\text{ °C}$

$I_F = f(t_p)$; true green; 3 Chips on

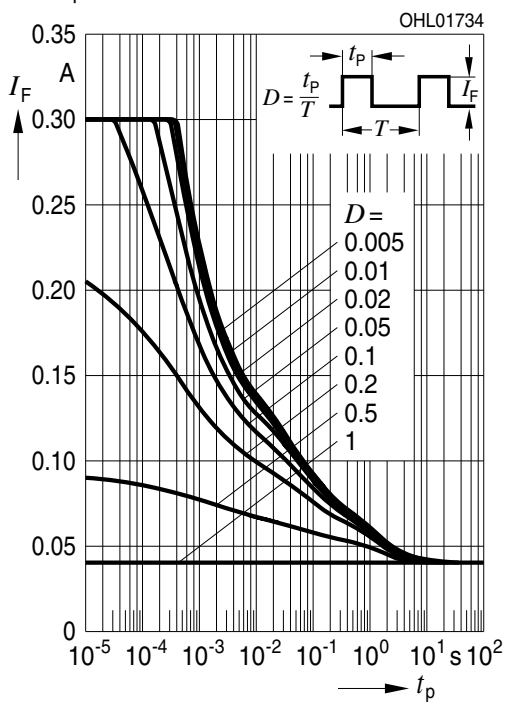

Zulässige Impulsbelastbarkeit
Permissible Pulse Handling Capability

Duty cycle $D =$ parameter, $T_A = 85\text{ °C}$

$I_F = f(t_p)$; true green; 3 Chips on

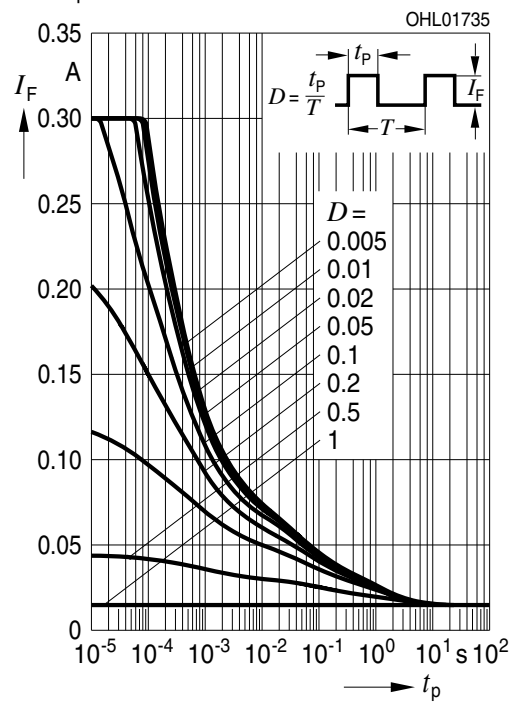

Zulässige Impulsbelastbarkeit
Permissible Pulse Handling Capability

Duty cycle $D =$ parameter, $T_A = 25\text{ °C}$

$I_F = f(t_p)$; blue; 1 chip on

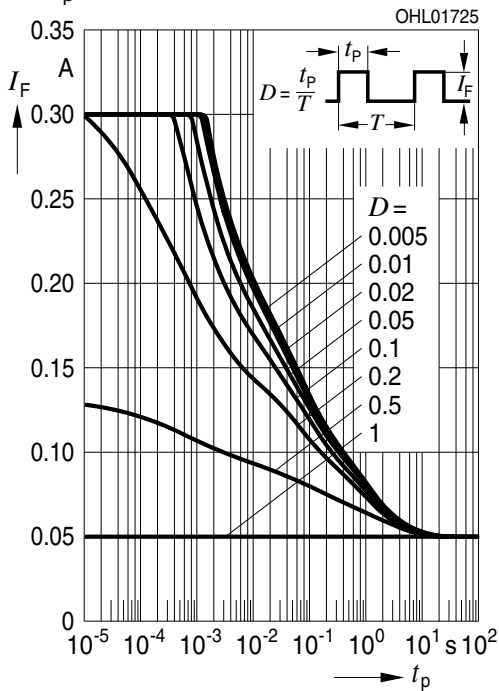

Zulässige Impulsbelastbarkeit
Permissible Pulse Handling Capability

Duty cycle $D =$ parameter, $T_A = 85\text{ °C}$

$I_F = f(t_p)$; blue; 1 chip on

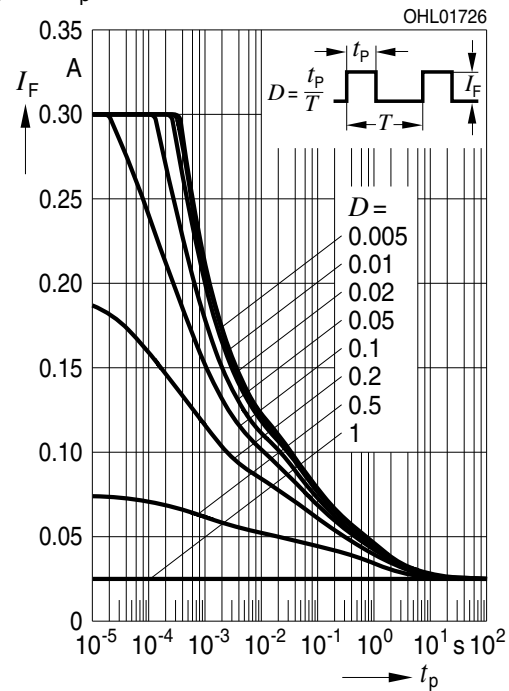

Zulässige Impulsbelastbarkeit
Permissible Pulse Handling Capability

Duty cycle $D =$ parameter, $T_A = 25\text{ °C}$

$I_F = f(t_p)$; blue (3 Chips on)

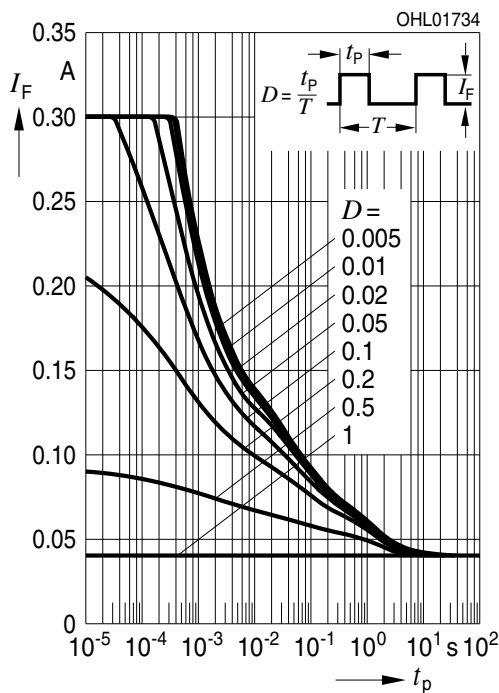

Zulässige Impulsbelastbarkeit
Permissible Pulse Handling Capability

Duty cycle $D =$ parameter, $T_A = 85\text{ °C}$

$I_F = f(t_p)$; blue (3 Chips on)

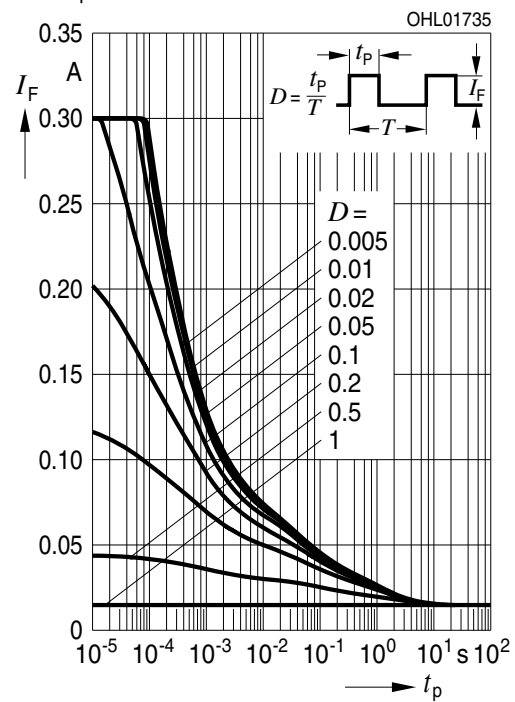

Maßzeichnung⁸⁾ Seite 23
 Package Outlines⁸⁾ page 23

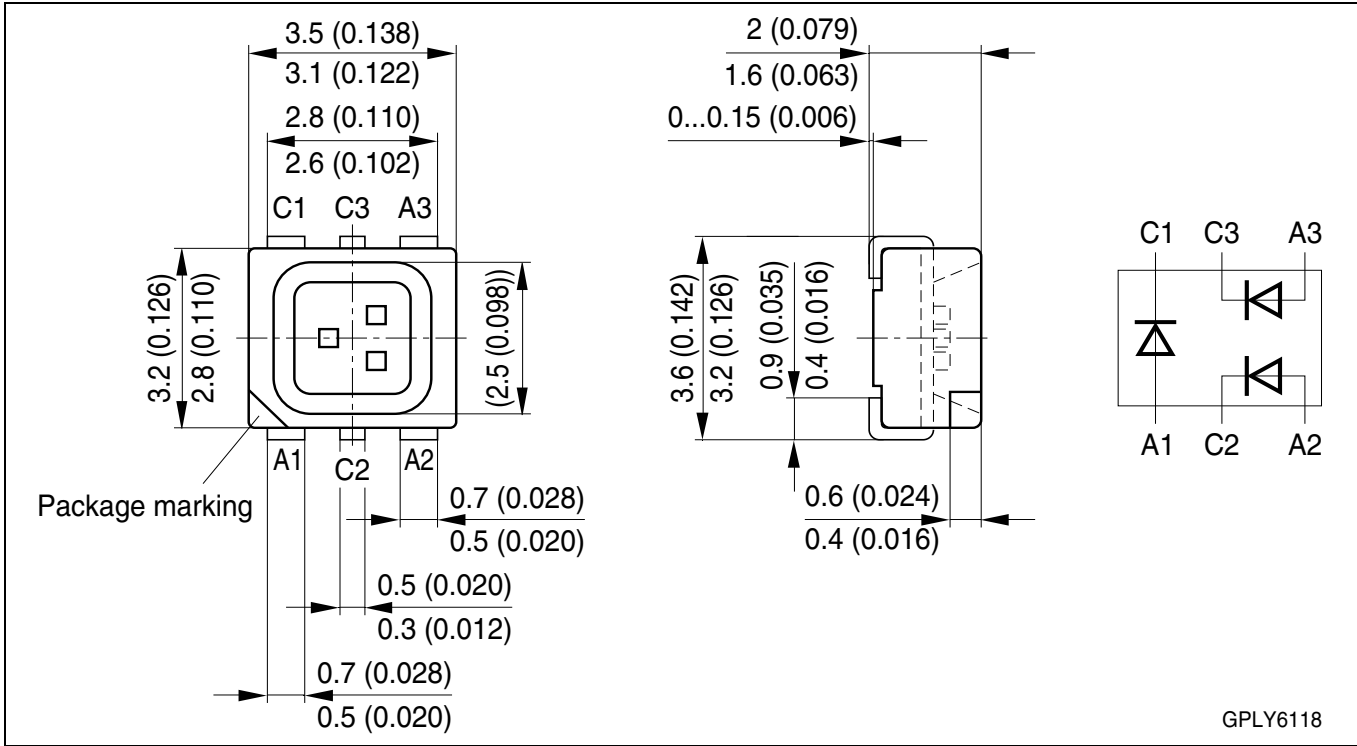

Pin-Assignment:

- C1: Cathode; RED (R)
- A1: Anode; RED (R)
- C2: Cathode; TRUE GREEN (T)
- A2: Anode; TRUE GREEN (T)
- C3: Cathode; BLUE (B)
- A3: anode; BLUE (B)

Gewicht / Approx. weight:

40 mg

Gurtung / Polarität und Lage⁸⁾ Seite 23

Verpackungseinheit 1000/Rolle, ø180 mm

Method of Taping / Polarity and Orientation⁸⁾ page 23

Packing unit 1000/reel, ø180 mm

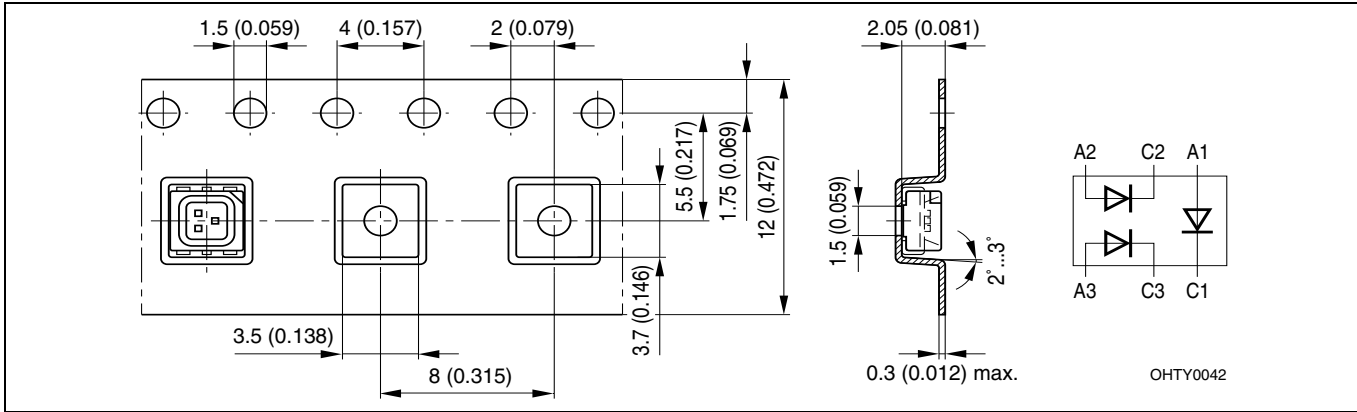

Empfohlenes Lötpadding^{8) 9) Seite 23}
Recommended Solder Pad^{8) 9) page 23}

IR Reflow Löten
IR Reflow Soldering

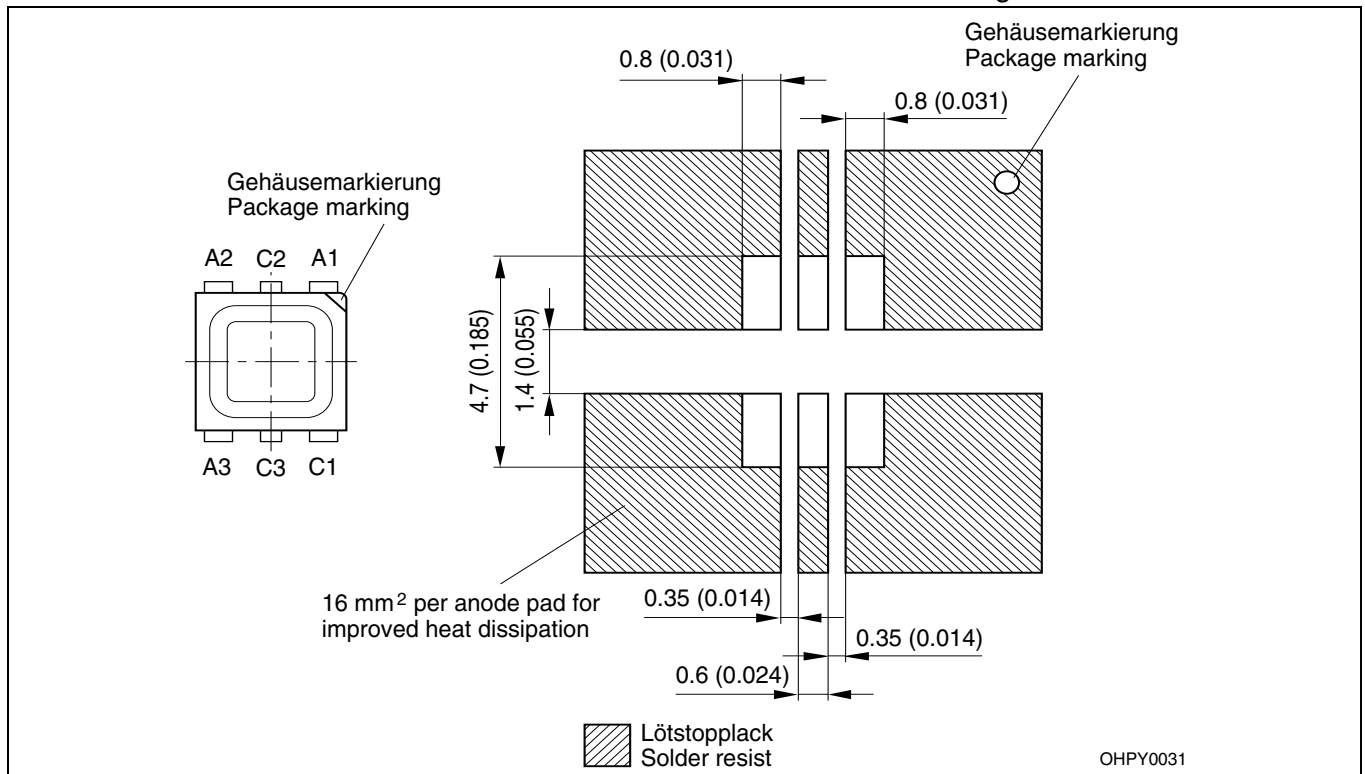

Empfohlenes Platinendesign für cluster mit 6-lead TOPLLED® in Serienschaltung
Recommended PCB-Design for cluster with 6-lead TOPLLED® in Series Connection

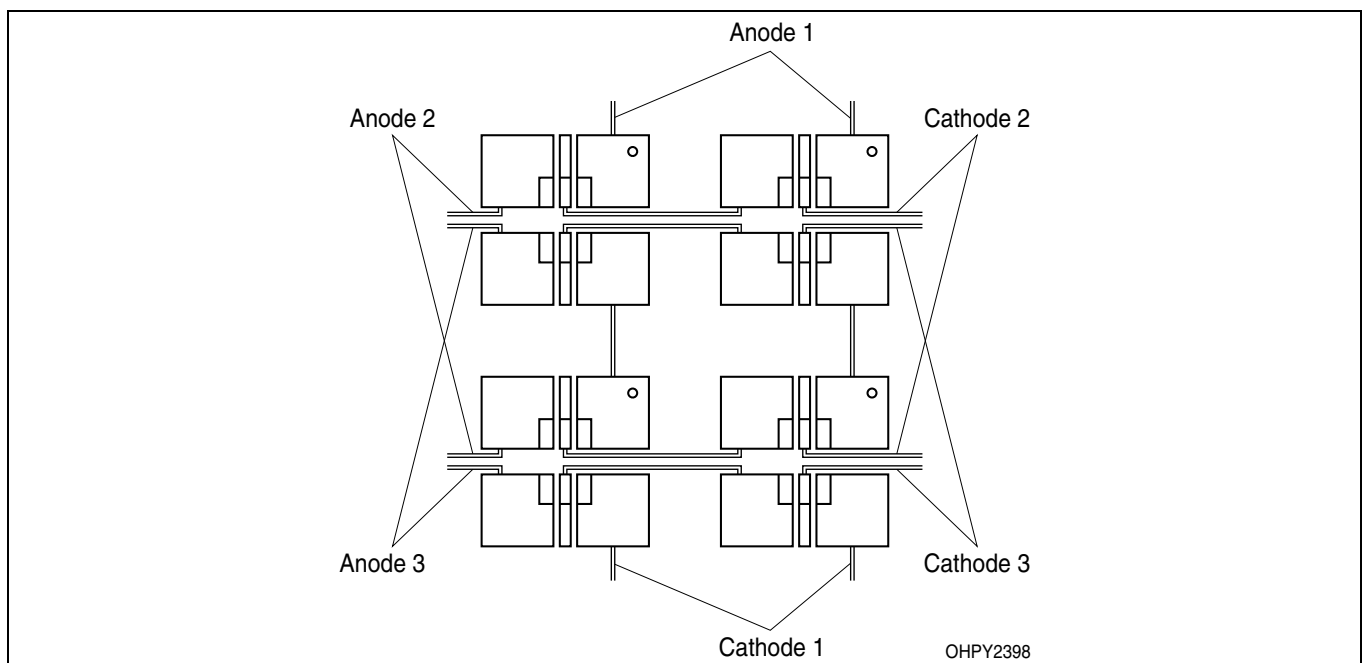

Lötbedingungen
Soldering Conditions

Vorbehandlung nach JEDEC Level 4
Preconditioning acc. to JEDEC Level 4

Reflow Lötprofil für bleifreies Löt
Reflow Soldering Profile for lead free soldering

(nach J-STD-020D.01)
(acc. to J-STD-020D.01)

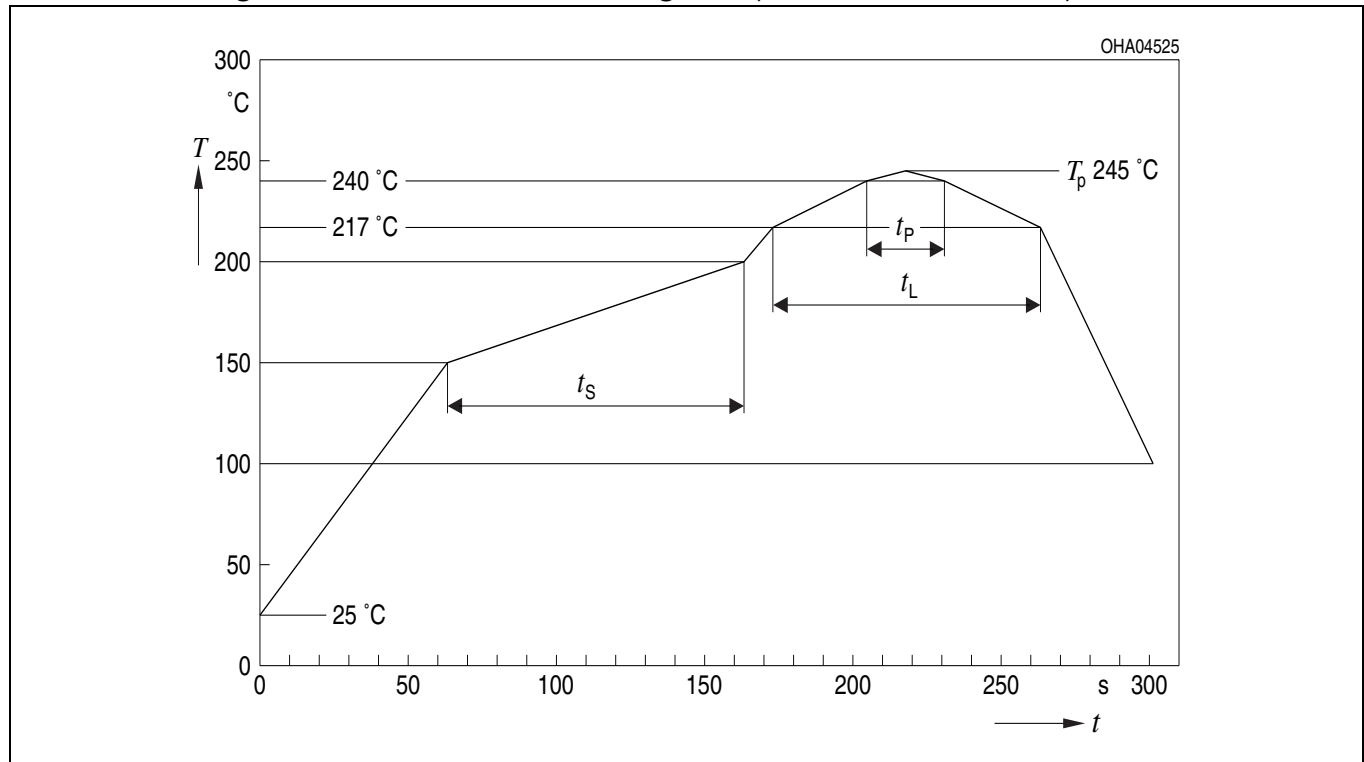

Profile Feature	Pb-Free (SnAgCu) Assembly	
	Recommendation	Max. Ratings
Ramp-up Rate to Preheat*) 25°C to 150°C	2°C / sec	3°C / sec
Time t_s from T_{Smin} to T_{Smax} (150°C to 200°C)	100s	min. 60sec max. 120sec
Ramp-up Rate to Peak*) 180°C to T_p	2°C / sec	3°C / sec
Liquidus Temperature T_L	217°C	
Time t_L above T_L	80sec	max. 100sec
Peak Temperature T_p	245°C	max. 260°C
Time t_p within 5°C of the specified peak temperature T_p - 5K	20sec	min. 10sec max. 30sec
Ramp-down Rate* T_p to 100°C	3°K / sec	6°K / sec maximum
Time 25°C to Peak temperature		max. 8 min.

All temperatures refer to the center of the package, measured on the top of the component
* slope calculation $\Delta T/\Delta t$: Δt max. 5 sec; fulfillment for the whole T-range

Barcode-Produkt-Etikett (BPL)
Barcode-Product-Label (BPL)

OSRAM Opto Semiconductors

(6P) BATCH NO: 1004109518



(1T) LOT NO: 1234567890 (9D) D/C: 1016



(X) PROD NO: 11055131 (Q) QTY: 4000 (G) GROUP: U5-1-0+V9-5-0+S7-6-0



LRTBGFTG BIN1: U5-1-0-20
 6-LEAD MULTILED BIN2: V9-5-0-20
 RoHS Compliant BIN3: S7-6-0-20

ML Temp ST
 4 260 °C R

Pack: R33
 DEMY 031
 B_R999_1011.1241_R



OHA04614

Gurtverpackung
Tape and Reel

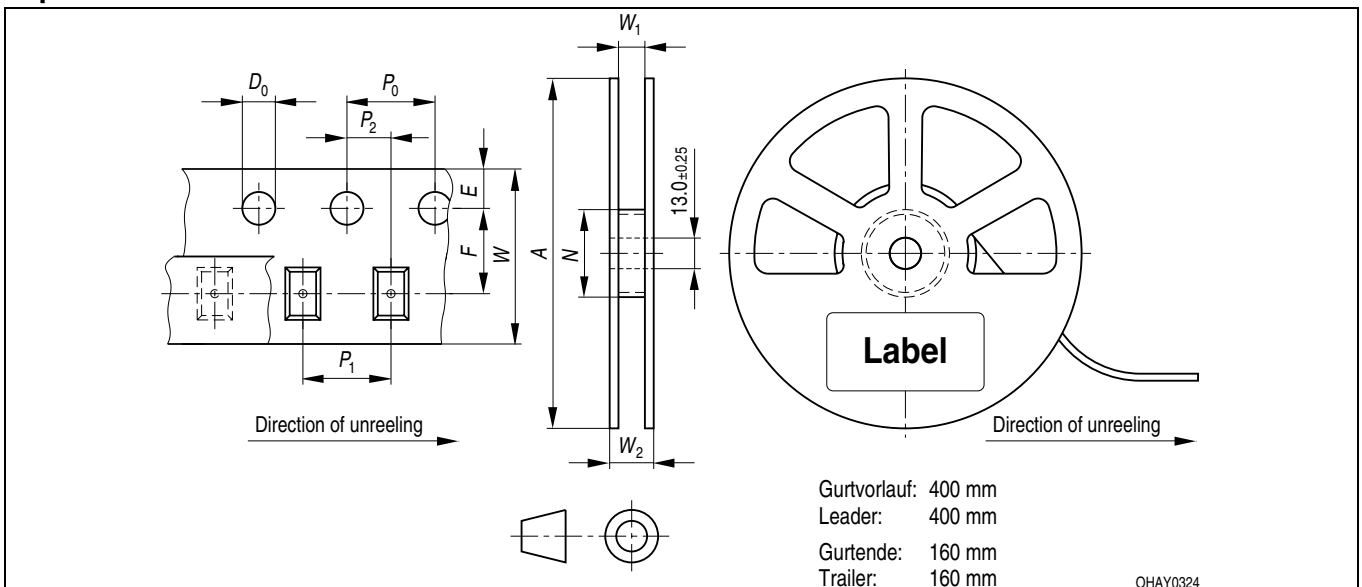

Tape dimensions in mm (inch)

W	P ₀	P ₁	P ₂	D ₀	E	F
12 ^{+0.3} D 0.1	4 ± 0.1 (0.157 ± 0.004)	8 ± 0.1 (0.315 ± 0.004)	2 ± 0.05 (0.079 ± 0.002)	1.5 ± 0.1 (0.059 ± 0.004)	1.75 ± 0.1 (0.069 ± 0.004)	5.5 ± 0.05 (0.217 ± 0.002)

Reel dimensions in mm (inch)

A	W	N _{min}	W ₁	W _{2 max}
180 (7)	12 (0.472)	60 (2.362)	12.4 + 2 (0.488 + 0.079)	18.4 (0.724)
330 (13)	12 (0.472)	60 (2.362)	12.4 + 2 (0.488 + 0.079)	18.4 (0.724)

Trockenverpackung und Materialien
Dry Packing Process and Materials

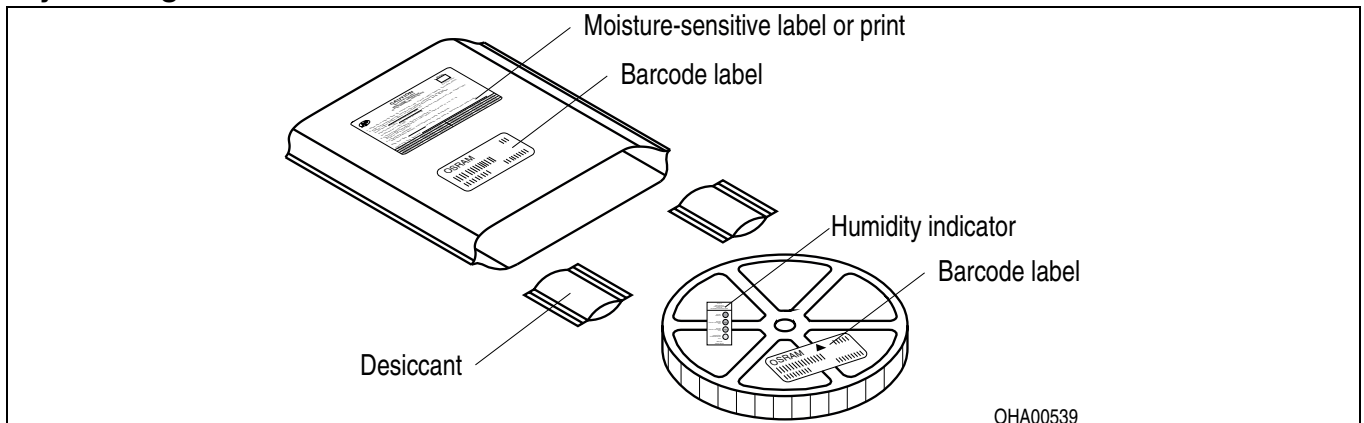

Anm.: Feuchteempfindliche Produkte sind verpackt in einem Trockenbeutel zusammen mit einem Trockenmittel und einer Feuchteindikatorkarte
 Bezüglich Trockenverpackung finden Sie weitere Hinweise im Internet und in unserem Short Form Catalog im Kapitel "Gurtung und Verpackung" unter dem Punkt "Trockenverpackung". Hier sind Normenbezüge, unter anderem ein Auszug der JEDEC-Norm, enthalten.

Note: Moisture-sensitive product is packed in a dry bag containing desiccant and a humidity card.
 Regarding dry pack you will find further information in the internet and in the Short Form Catalog in chapter "Tape and Reel" under the topic "Dry Pack". Here you will also find the normative references like JEDEC.

Kartonverpackung und Materialien
Transportation Packing and Materials

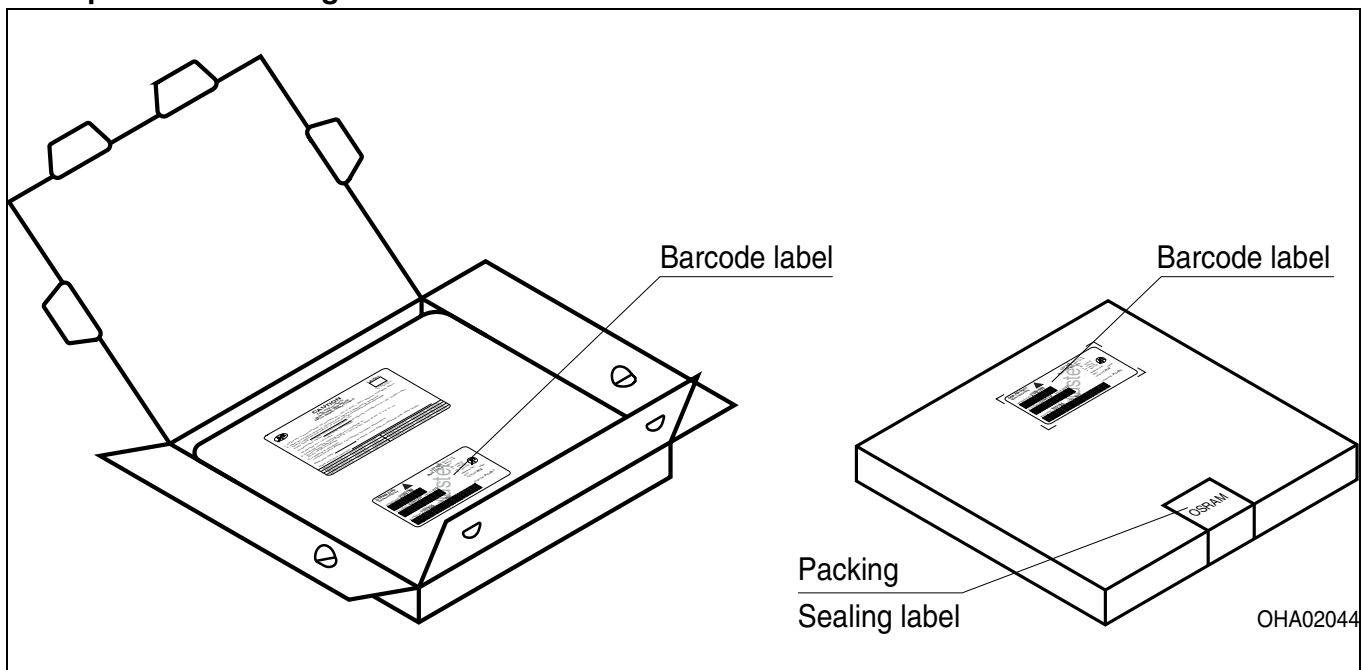

Dimensions of transportation box in mm (inch)

Breite / Width	Länge / length	Höhe / height
200 ±5 (7,874 ±0,1968±)	200 ±5 (7,874 ±0,1968)	30 ±5 (1,1811 ±0,1968)

Revision History: 2010-12-02

Previous Version: 2010-10-04

Page	Subjects (major changes since last revision)	Date of change
20	OS-IN-2010-032	2010-10-04
all	Final datasheet created	2010-12-02

Attention please!

The information describes the type of component and shall not be considered as assured characteristics. Terms of delivery and rights to change design reserved. Due to technical requirements components may contain dangerous substances. For information on the types in question please contact our Sales Organization. If printed or downloaded, please find the latest version in the Internet.

Packing

Please use the recycling operators known to you. We can also help you – get in touch with your nearest sales office. By agreement we will take packing material back, if it is sorted. You must bear the costs of transport. For packing material that is returned to us unsorted or which we are not obliged to accept, we shall have to invoice you for any costs incurred.

Components used in life-support devices or systems must be expressly authorized for such purpose! Critical components^{10) page 23} may only be used in life-support devices or systems^{11) page 23} with the express written approval of OSRAM OS.

Fußnoten:

- 1) Helligkeitswerte werden mit einer Stromeinprägedauer von 25 ms und einer Genauigkeit von $\pm 11\%$ ermittelt.
- 2) Die LED kann kurzzeitig in Sperrichtung betrieben werden.
- 3) R_{thJA} ergibt sich bei Montage auf PC-Board FR 4 (Padgröße $\geq 16 \text{ mm}^2$ je Pad)
- 4) Wellenlängen werden mit einer Stromeinprägedauer von 25 ms und einer Genauigkeit von $\pm 1 \text{ nm}$ ermittelt.
- 5) Spannungswerte werden mit einer Stromeinprägedauer von 1 ms und einer Genauigkeit von $\pm 0,1 \text{ V}$ ermittelt.
- 6) Wegen der besonderen Prozessbedingungen bei der Herstellung von LED können typische oder abgeleitete technische Parameter nur aufgrund statistischer Werte wiedergegeben werden. Diese stimmen nicht notwendigerweise mit den Werten jedes einzelnen Produktes überein, dessen Werte sich von typischen und abgeleiteten Werten oder typischen Kennlinien unterscheiden können. Falls erforderlich, z.B. aufgrund technischer Verbesserungen, werden diese typischen Werte ohne weitere Ankündigung geändert.
- 7) Im gestrichelten Bereich der Kennlinien muss mit erhöhten Helligkeitsunterschieden zwischen Leuchtdioden innerhalb einer Verpackungseinheit gerechnet werden.
Dimmverhältnis im Gleichstrom-Betrieb max. 5:1 für red
- 8) Maße werden wie folgt angegeben: mm (inch)
- 9) Gehäuse hält TTW-Löthitze aus nach CECC 00802
- 10) Ein kritisches Bauteil ist ein Bauteil, das in lebenserhaltenden Apparaten oder Systemen eingesetzt wird und dessen Defekt voraussichtlich zu einer Fehlfunktion dieses lebenserhaltenden Apparates oder Systems führen wird oder die Sicherheit oder Effektivität dieses Apparates oder Systems beeinträchtigt.
- 11) Lebenserhaltende Apparate oder Systeme sind für
(a) die Implantierung in den menschlichen Körper oder
(b) für die Lebenserhaltung bestimmt.
Falls sie versagen, kann davon ausgegangen werden, dass die Gesundheit und das Leben des Patienten in Gefahr ist.

Remarks:

- 1) Brightness groups are tested at a current pulse duration of 25 ms and a tolerance of $\pm 11\%$.
- 2) Driving the LED in reverse direction is suitable for short term application.
- 3) R_{thJA} results from mounting on PC board FR 4 (pad size $\geq 16 \text{ mm}^2$ per pad)
- 4) Wavelengths are tested at a current pulse duration of 25 ms and a tolerance of $\pm 1 \text{ nm}$.
- 5) Forward voltages are tested at a current pulse duration of 1 ms and a tolerance of $\pm 0.1 \text{ V}$.
- 6) Due to the special conditions of the manufacturing processes of LED, the typical data or calculated correlations of technical parameters can only reflect statistical figures. These do not necessarily correspond to the actual parameters of each single product, which could differ from the typical data and calculated correlations or the typical characteristic line. If requested, e.g. because of technical improvements, these typ. data will be changed without any further notice.
- 7) In the range where the line of the graph is broken, you must expect higher brightness differences between single LEDs within one packing unit.
Dimming range for direct current mode max. 5:1 for red
- 8) Dimensions are specified as follows: mm (inch)
- 9) Package able to withstand TTW-soldering heat acc. to CECC 00802
- 10) A critical component is a component used in a life-support device or system whose failure can reasonably be expected to cause the failure of that life-support device or system, or to affect its safety or the effectiveness of that device or system.
- 11) Life support devices or systems are intended
(a) to be implanted in the human body,
or
(b) to support and/or maintain and sustain human life.
If they fail, it is reasonable to assume that the health and the life of the user may be endangered.

Published by
OSRAM Opto Semiconductors GmbH
 Wernerwerkstrasse 2, D-93049 Regensburg
www.osram-os.com
 © All Rights Reserved.

EU RoHS and China RoHS compliant product



此产品符合欧盟 RoHS 指令的要求；
 按照中国的相关法规和标准，不含有毒有害物质或元素。